

Charging via USB Type-C

Use a genuine Samsung AFC adaptor for 9V fast charging. Use a minimum 5V/2A rated USB adaptor for 5V normal charging. (A)

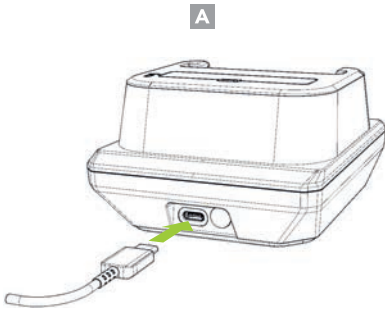

*Fast charging is only supported when using a genuine Samsung AFC charger.

Charging via DC Connector

The 12V/2A DC power adaptor (Optional) supports 9V fast charging when the XCover Pro is mounted on the charging cradle. (B)

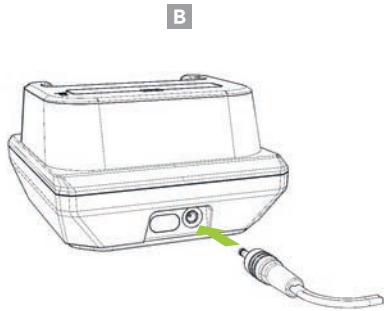

Removing the Battery Cover

To remove, pull the hook on the battery cover forward and tilt it upwards. (E)

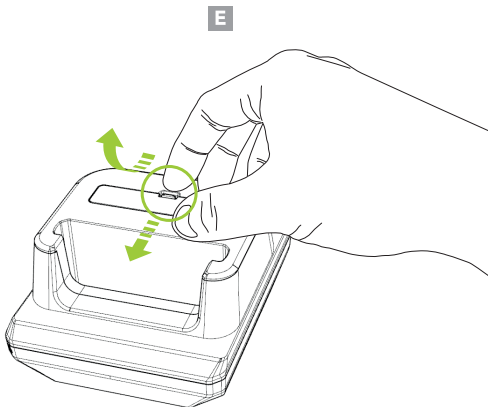

5-Slot Charging via DC Connector

The 12V/10A DC power adaptor supports 9V fast charging when the XCover Pro is mounted on the 5-slot charging cradle. (C)

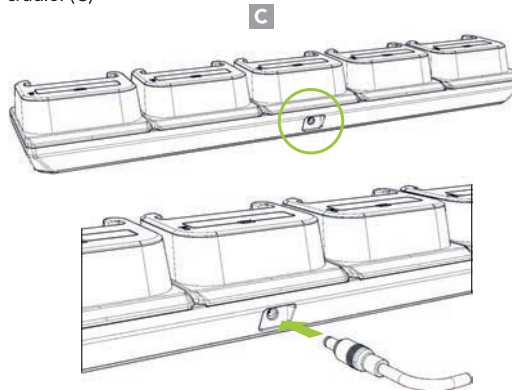

Charging the XCover Pro Battery

The battery's charging terminal is located on the bottom left of the battery when viewed from the front. Align the left side of the battery with the left side of the XCover Pro battery slot and insert the battery. (F)

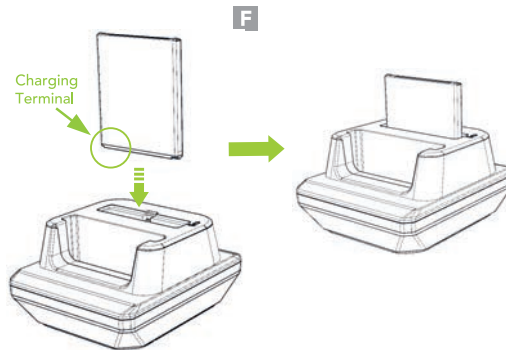

KOAMTAC

XCover Pro
Charging Cradle Mini Guide

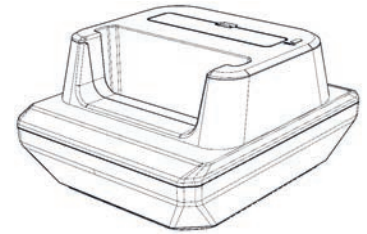

KOAMTAC

116 Village Blvd, Ste 305, Princeton, NJ 08540
+1 609-256-4700 [p](#) | +1 609-228-4373 [f](#)
info@koamtac.com | www.koamtac.com

Charging the XCover Pro

Insert the XCover Pro into the XCover Pro slot as shown below. (D)

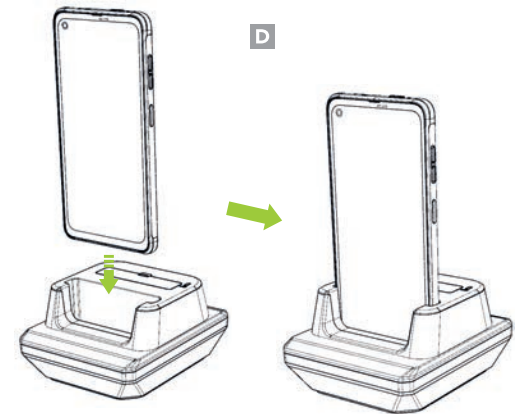

Cradle Power LED Status

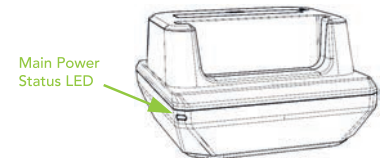

Green : Always on when the cradle is powered on

Battery LED Status



Green: Fully charged
Orange: Charging

Blinking Red: Charging Issue

- Overheating
- Charging fault
- Foreign material inside